

# INTERIOR UTILITY & DOME LIGHTS

## LED

Pages 290-297

SERIES	COMMON SIZE	PAGES
33® Series	0.75"	290-291
Super 33®	0.75"	292-293
36 Series	1" x 2"	293
44® Series	4"	294
Super 44®	4"	295
80 Series	Multiple	296-297
84 Series	2" x 48"	297
Signal-Stat 3in x 10in	3" x 10"	297

## INCANDESCENT

Pages 298-305

SERIES	COMMON SIZE	PAGES
10® Series	2" x 5"	298
Super 10® Series	2" x 5"	298
12® Series	2" x 3"	299
15® Series	1" x 2"	299
19® Series	1" x 4"	299
20® Series	2"	300
26 Series	Multiple	300
30® Series	2"	300
40® Series	4"	301-302
Incandescent 1 Bulb	Multiple	302-303
Incandescent Signal-Stat	Multiple	304-305

## FLUORESCENT

Page 306

SERIES	COMMON SIZE	PAGES
2 Bulb 5in x 18in	5" x 18"	306
2 Bulb 6in x 21in	6" x 21"	306

LED

33 SERIES

### 33<sup>®</sup> SERIES, LED, 1 DIODE, 0.75", GROMMET MOUNT

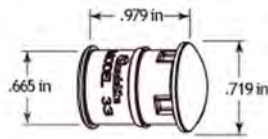

- Excellent choice for interior applications such as truck cab, walkways, glove boxes, step lights, puddle lights and more
- Creates additional options for improving custom look and theme of vehicle exteriors, mounted on separate switch
- Hardwired lamp design easily retrofitted
- Low profile reduces damage from impact
- LEDs draw less current, allowing more power for other vehicle requirements
- Reduces lighting costs due to physical damage and heat entrapment
- Electronics completely sealed in epoxy to resist corrosion and moisture
- Designed for auxiliary lamp use only
- US Patent #6612728
- Not recommended for marker/clearance purposes



Part Number	Lamp Connector	Plug Side 1	Plug Side 2	Lens Color	Lens Material	Volts	Amps
33265B	Hardwired	Hardwired	.180 Bullet	Blue	PC	12	0.04
33265C	Hardwired	Hardwired	.180 Bullet	Clear	PC	12	0.04
33265G	Hardwired	Hardwired	.180 Bullet	Green	PC	12	0.04
33265PR	Hardwired	Hardwired	.180 Bullet	Purple	PC	12	0.04
33265R	Hardwired	Hardwired	.180 Bullet	Red	PC	12	0.04
33265Y	Hardwired	Hardwired	.180 Bullet	Yellow	PC	12	0.04

LED

33 SERIES

### 33<sup>®</sup> SERIES, LED, 1 DIODE, 0.75", GROMMET MOUNT, KIT

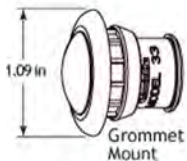

- Excellent choice for interior applications such as truck cab, walkways, glove boxes, step lights, puddle lights and more
- Creates additional options for improving custom look and theme of vehicle exteriors, mounted on separate switch
- Hardwired lamp design easily retrofitted
- Low profile reduces damage from impact
- LEDs draw less current, allowing more power for other vehicle requirements
- Reduces lighting costs due to physical damage and heat entrapment
- Electronics completely sealed in epoxy to resist corrosion and moisture
- Designed for auxiliary lamp use only
- US Patent #6612728
- Not recommended for marker/clearance purposes



Part Number	Lamp Connector	Plug Side 1	Plug Side 2	Lens Color	Lens Material	Mount Color	Volts	Amps	Kit Includes
33060PR	Hardwired	Hardwired	.180 Bullet	Purple	PC	Black	12	0.13	33260PR light, 33700 grommet
33065B	Hardwired	Hardwired	.180 Bullet	Blue	PC	Black	12	0.06	33265B light, 33700 grommet
33065C	Hardwired	Hardwired	.180 Bullet	Clear	PC	Black	12	0.06	33265C light, 33700 grommet
33065G	Hardwired	Hardwired	.180 Bullet	Green	PC	Black	12	0.06	33265G light, 33700 grommet
33065PR	Hardwired	Hardwired	.180 Bullet	Purple	PC	Black	12	0.06	33265PR light, 33700 grommet
33065R	Hardwired	Hardwired	.180 Bullet	Red	PC	Black	12	0.06	33265R light, 33700 grommet
33065Y	Hardwired	Hardwired	.180 Bullet	Yellow	PC	Black	12	0.06	33265Y light, 33700 grommet
33095G	Hardwired	Hardwired	.180 Bullet	Green	PC	Black	12	0.06	33265G light, 33725 grommet

## 33<sup>®</sup> SERIES, LED, 1 DIODE, 0.75", FLANGE MOUNT, KIT



- Excellent choice for interior applications such as truck cab, walkways, glove boxes, step lights, puddle lights and more
- Creates additional options for improving custom look and theme of vehicle exteriors, mounted on separate switch
- Hardwired lamp design easily retrofitted
- Low profile reduces damage from impact
- LEDs draw less current, allowing more power for other vehicle requirements
- Reduces lighting costs due to physical damage and heat entrapment
- Electronics completely sealed in epoxy to resist corrosion and moisture
- Designed for auxiliary lamp use only
- US Patent #6612728
- Not recommended for marker/clearance purposes

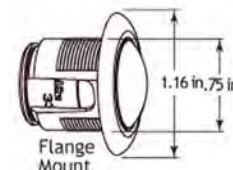

Part Number	Lamp Connector	Plug Side 1	Plug Side 2	Lens Color	Lens Material	Mount Color	Volts	Amps	Kit Includes
33062PR	Hardwired	Hardwired	.180 Bullet	Purple	PC	Chrome	12	0.13	33260PR light, 33810 grommet
33066B	Hardwired	Hardwired	.180 Bullet	Blue	PC	Black	12	0.06	33265B light, 33800 grommet
33066C	Hardwired	Hardwired	.180 Bullet	Clear	PC	Black	12	0.06	33265C light, 33800 grommet
33066G	Hardwired	Hardwired	.180 Bullet	Green	PC	Black	12	0.06	33265G light, 33800 grommet
33066PR	Hardwired	Hardwired	.180 Bullet	Purple	PC	Black	12	0.06	33265PR light, 33800 grommet
33066R	Hardwired	Hardwired	.180 Bullet	Red	PC	Black	12	0.06	33265R light, 33800 grommet
33066Y	Hardwired	Hardwired	.180 Bullet	Yellow	PC	Black	12	0.06	33265Y light, 33800 grommet
33067B	Hardwired	Hardwired	.180 Bullet	Blue	PC	Chrome	12	0.06	33265B light, 33810 grommet
33067C	Hardwired	Hardwired	.180 Bullet	Clear	PC	Chrome	12	0.06	33265C light, 33810 grommet
33067G	Hardwired	Hardwired	.180 Bullet	Green	PC	Chrome	12	0.06	33265G light, 33810 grommet
33067PR	Hardwired	Hardwired	.180 Bullet	Purple	PC	Chrome	12	0.06	33265PR light, 33810 grommet
33067R	Hardwired	Hardwired	.180 Bullet	Red	PC	Chrome	12	0.06	33265R light, 33810 grommet
33067Y	Hardwired	Hardwired	.180 Bullet	Yellow	PC	Chrome	12	0.06	33265Y light, 33810 grommet

## SUPER 33, LED, 1 DIODE, 0.75", GROMMET MOUNT

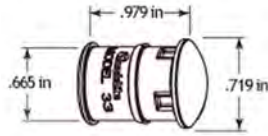

- Excellent choice for interior applications such as truck cab, walkways, glove boxes, step lights, puddle lights and more
- Creates additional options for improving custom look and theme of vehicle exteriors, mounted on separate switch
- Hardwired lamp design easily retrofitted
- Low profile reduces damage from impact
- LEDs draw less current, allowing more power for other vehicle requirements
- Reduces lighting costs due to physical damage and heat entrapment
- Electronics completely sealed in epoxy to resist corrosion and moisture
- Designed for auxiliary lamp use only
- US Patent #6612728
- Not recommended for marker/clearance purposes



Part Number	Lamp Connector	Plug Side 1	Plug Side 2	Lens Color	Lens Material	Volts	Amps
33260B	Hardwired	Hardwired	.180 Bullet	Blue	PC	12	0.13
33260C	Hardwired	Hardwired	.180 Bullet	Clear	PC	12	0.13
33260G	Hardwired	Hardwired	.180 Bullet	Green	PC	12	0.13
33260PR	Hardwired	Hardwired	.180 Bullet	Purple	PC	12	0.13
33260R	Hardwired	Hardwired	.180 Bullet	Red	PC	12	0.13
33260Y	Hardwired	Hardwired	.180 Bullet	Yellow	PC	12	0.13

## SUPER 33, LED, 1 DIODE, 0.75", GROMMET MOUNT, KIT

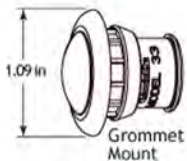

- Excellent choice for interior applications such as truck cab, walkways, glove boxes, step lights, puddle lights and more
- Creates additional options for improving custom look and theme of vehicle exteriors, mounted on separate switch
- Hardwired lamp design easily retrofitted
- Low profile reduces damage from impact
- LEDs draw less current, allowing more power for other vehicle requirements
- Reduces lighting costs due to physical damage and heat entrapment
- Electronics completely sealed in epoxy to resist corrosion and moisture
- Designed for auxiliary lamp use only
- US Patent #6612728
- Not recommended for marker/clearance purposes



Part Number	Lamp Connector	Plug Side 1	Plug Side 2	Lens Color	Lens Material	Mount Color	Volts	Amps	Kit Includes
33060B	Hardwired	Hardwired	.180 Bullet	Blue	PC	Black	12	0.13	33260B light, 33700 grommet
33060C	Hardwired	Hardwired	.180 Bullet	Clear	PC	Black	12	0.13	33260C light, 33700 grommet
33060G	Hardwired	Hardwired	.180 Bullet	Green	PC	Black	12	0.13	33260G light, 33700 grommet
33060R	Hardwired	Hardwired	.180 Bullet	Red	PC	Black	12	0.13	33260R light, 33700 grommet
33060Y	Hardwired	Hardwired	.180 Bullet	Yellow	PC	Black	12	0.13	33260Y light, 33700 grommet

## SUPER 33, LED, 1 DIODE, 0.75", FLANGE MOUNT, KIT



- Excellent choice for interior applications such as truck cab, walkways, glove boxes, step lights, puddle lights and more
- Creates additional options for improving custom look and theme of vehicle exteriors, mounted on separate switch
- Hardwired lamp design easily retrofitted
- Low profile reduces damage from impact
- LEDs draw less current, allowing more power for other vehicle requirements
- Reduces lighting costs due to physical damage and heat entrapment
- Electronics completely sealed in epoxy to resist corrosion and moisture
- Designed for auxiliary lamp use only
- US Patent #6612728
- Not recommended for marker/clearance purposes



Part Number	Lamp Connector	Plug Side 1	Plug Side 2	Lens Color	Lens Material	Mount Color	Volts	Amps	Kit Includes
33061B	Hardwired	Hardwired	.180 Bullet	Blue	PC	Black	12	0.13	33260B light, 33800 grommet
33061C	Hardwired	Hardwired	.180 Bullet	Clear	PC	Black	12	0.13	33260C light, 33800 grommet
33061G	Hardwired	Hardwired	.180 Bullet	Green	PC	Black	12	0.13	33260G light, 33800 grommet
33061PR	Hardwired	Hardwired	.180 Bullet	Purple	PC	Black	12	0.13	33260PR light, 33800 grommet
33061R	Hardwired	Hardwired	.180 Bullet	Red	PC	Black	12	0.13	33260R light, 33800 grommet
33061Y	Hardwired	Hardwired	.180 Bullet	Yellow	PC	Black	12	0.13	33260Y light, 33800 grommet
33062B	Hardwired	Hardwired	.180 Bullet	Blue	PC	Chrome	12	0.13	33260B light, 33810 grommet
33062C	Hardwired	Hardwired	.180 Bullet	Clear	PC	Chrome	12	0.13	33260C light, 33800 grommet
33062G	Hardwired	Hardwired	.180 Bullet	Green	PC	Chrome	12	0.13	33260G light, 33810 grommet
33062R	Hardwired	Hardwired	.180 Bullet	Red	PC	Chrome	12	0.13	33260R light, 33810 grommet
33062Y	Hardwired	Hardwired	.180 Bullet	Yellow	PC	Chrome	12	0.13	33260Y light, 33810 grommet

## 36 SERIES, LED, 3 DIODE, 1" X 2", ADHESIVE MOUNT



- Provides robust LED white lighting solution that does not require mounting brackets or installation screws
- Light adheres directly to mounting surface with heavy-duty adhesive backing, with an easy-to-install, peel-off liner
- OmniVolt design makes the 36 Series auxiliary light perfect for any type of vehicle system
- Small profile makes it ideal for interior, tool box, storage, under cabinet, and other small spaces
- Perfect for rock lights in off-road application
- Electronics are completely sealed in epoxy to resist damage caused by moisture, corrosion, shock and vibration

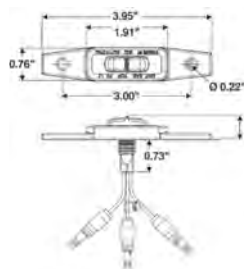

36214C / 36215C

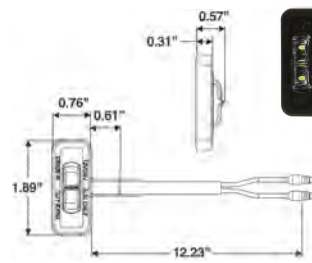

36204C / 36205C

Part Number	Lamp Connector	Plug Side 1	Plug Side 2	Lens Color	Lens Material	Mount Color	Volts	Amps	Wire Location
36204C	Hardwired	Hardwired	.180 Bullet	Clear	PC	Black	12 24	0.05	Rear Exit
36205C	Hardwired	Hardwired	.180 Bullet	Clear	PC	Black	12 24	0.05	Side Exit
36214C	Hardwired	Hardwired	.180 Bullet	Clear	PC	Black	12 24	0.05	Rear Exit
36215C	Hardwired	Hardwired	.180 Bullet	Clear	PC	Black	12 24	0.05	Side Exit

### 44<sup>®</sup> SERIES, LED, 54 DIODE, 4" , GROMMET MOUNT

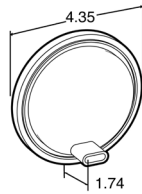

- Popular in trailer and body applications
- 85% reduction of load on electrical system allows more power for other vehicle requirements
- Virtually impervious to shock and vibration



Part Number	Lamp Connector	Plug Side 1	Plug Side 2	Lens Color	Lens Material	Volts	Amps
44207C	Fit 'N Forget S.S.	No Plug	No Plug	Clear	PC	12	0.11

### 44<sup>®</sup> SERIES, LED, 54 DIODE, 4" , GROMMET MOUNT, KIT



- Popular in trailer and body applications
- 85% reduction of load on electrical system allows more power for other vehicle requirements
- Virtually impervious to shock and vibration



Part Number	Lamp Connector	Plug Side 1	Plug Side 2	Lens Color	Lens Material	Mount Color	Volts	Amps	Kit Includes
44042C	Fit 'N Forget S.S.	Fit 'N Forget S.S.	Female PL-2	Clear	PC	Black	12	0.11	44307C light, 40700 grommet, 94789 plug

### 44<sup>®</sup> SERIES, LED, 54 DIODE, 4" , FLANGE MOUNT



- Popular in trailer and body applications
- 85% reduction of load on electrical system allows more power for other vehicle requirements
- Virtually impervious to shock and vibration



Part Number	Lamp Connector	Plug Side 1	Plug Side 2	Lens Color	Lens Material	Mount Color	Volts	Amps
44237C	Fit 'N Forget S.S.	No Plug	No Plug	Clear	PC	Gray	12	0.11

### 44<sup>®</sup> SERIES, LED, 6 DIODE, 4" , GROMMET MOUNT, KIT

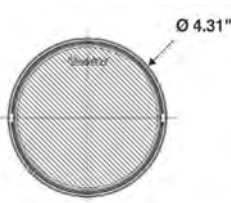

- Virtually impervious to shock and vibration



Part Number	Lamp Connector	Plug Side 1	Plug Side 2	Lens Color	Lens Material	Mount Color	Volts	Amps	Kit Includes
44057C	Hardwired	Hardwired	.180 Bullet	Clear	PC	Black	12	0.54	44308C light, 40700 grommet

LED

44 SERIES

LED

44 SERIES

LED

44 SERIES

LED

44 SERIES

## SUPER 44<sup>®</sup>, LED, 6 DIODE, 4", GROMMET MOUNT



- Low-profile lamp, approximately 1" deep for where space is at a premium
- Features robust and cost-effective design
- Virtually impervious to shock and vibration
- Epoxy-encapsulated electronics protect the lamp from damage caused by chemicals and moisture
- Designed to operate in extremely cold temperatures
- Broad light pattern with approximately 360 lumens of light output
- U.S. Registered TM #3483147

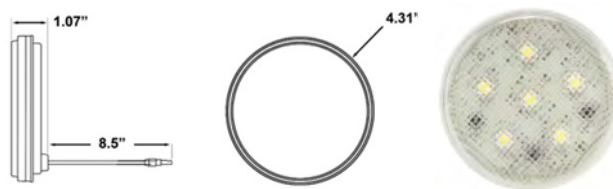

Part Number	Lamp Connector	Plug Side 1	Plug Side 2	Lens Color	Lens Material	Volts	Amps
44308C	Hardwired	Hardwired	.180 Bullet	Clear	PC	12	0.54

## SUPER 44<sup>®</sup>, LED, 6 DIODE, 4", FLANGE MOUNT



- Surface-mount design eliminates the need for large hole cutouts in trailer ceiling
- White housing design blends well with refrigerated trailer interiors
- Available with integrated on/off switch as well as externally controlled version
- Lens design recesses lens into housing to prevent damage from impact
- Not affected by cold temperatures, providing flicker-free lighting with a faster start-up time
- Ideal for refrigerated vehicles or those operating in cold weather
- Solid-state LED design is impervious to damage from shock and vibration
- Retrofit or replacement is quick and easy
- LED are fully encapsulated in epoxy to prevent damage caused by moisture and corrosives
- Recommend 3 #10 machine screws for mounting, with torque of 15-18 in-lbs

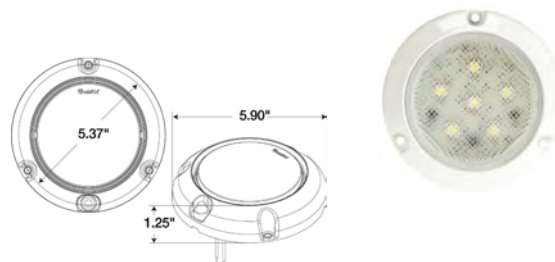

Part Number	Lamp Connector	Plug Side 1	Plug Side 2	Lens Color	Lens Material	Mount Color	Volts	Amps	Push Button Switch Y/N
44339C	Hardwired	Hardwired	.180 Bullet	Clear	PC	Gray	12	0.54	No
44439C	Hardwired	Hardwired	Stripped End	Clear	PC	White	12	0.54	No
44438C	Hardwired	Hardwired	Stripped End	Clear	PC	White	12	0.54	Yes
44352C	Hardwired	Hardwired	.180 Bullet	Clear	PC	White	12	0.54	No

## 80 SERIES, LED, 6 DIODE, 2" x 5", 4 SCREW BRACKET MOUNT

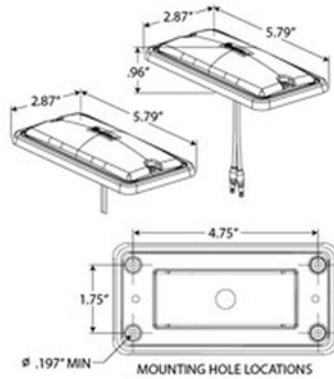

- U.S. Patent #7244058
- Die-cast aluminum housing
- White powder-coat finish
- Polycarbonate lens
- 10 White, 1W LEDs
- Lower profile than competitor lamps
- Nearly flush-mount, only .1" protrusion
- Not affected by cold temperatures
- LEDs provide whiter, brighter light
- Retrofit or replacement is quick and easy
- Flicker-free lighting in all temperatures



Part Number	Lamp Connector	Plug Side 1	Plug Side 2	Lens Color	Lens Material	Mount Color	Volts	Amps
80162C	Hardwired	Hardwired	Stripped End	Clear	PC	Black	12	0.38
80163C	Hardwired	Hardwired	Packard Connector	Clear	PC	Black	12	0.38
80164C	Hardwired	Hardwired	.180 Bullet	Clear	PC	Black	12	0.38

## 80 SERIES, LED, 6 DIODE, 6" x 16", 8 SCREW BRACKET MOUNT



- Patent Pending
- Not affected by cold temperatures
- LEDs provide whiter, brighter light
- Rugged aluminum housing and polycarbonate lens
- Electronics sealed in a conformal coating
- Weighs only 2 pounds
- Exclusive OmniVolt technology
- Standard size makes retrofit or replacement quick and easy



Part Number	Lamp Connector	Plug Side 1	Plug Side 2	Lens Color	Lens Material	Mount Color	Volts	Amps
80250C	Hardwired	Hardwired	Stripped End	Clear	PC	White	12 24	1.15

## 80 SERIES, LED, 10 DIODE, 2" x 13", 8 SCREW BRACKET MOUNT



- U.S. Patent #7244058
- Die cast aluminum housing
- White Powder coat finish
- Polycarbonate lens
- 10 White 1W LEDs
- Lower profile than competitive lamps
- Nearly flush mount, only .1" protrusion
- Not affected by cold temperatures
- LEDs provide whiter, brighter light
- Retrofit or replacement is quick and easy
- Flicker-free lighting in all temperatures



Part Number	Lamp Connector	Plug Side 1	Plug Side 2	Lens Color	Lens Material	Mount Color	Volts	Amps
80162C	Hardwired	Hardwired	Stripped End	Clear	PC	Black	12	0.38

## 80 SERIES, LED, 10 DIODE, 3" x 16", 8 SCREW BRACKET MOUNT



- Robust LED dome lamp w/motion sensor located in center of lamp to power lamp on
- Motion sensor determined by changes in heat and stays on through 5 minutes of inactivity
- Recognizes movement up to 10 feet away from lamp surface
- Nearly flush-mount design, with only .1 inch protrusion to allow more room in vehicle body
- Not affected by cold temperatures, providing flicker-free lighting with a faster start-up time
- Ideal for refrigerated vehicles or those operating in cold weather
- LEDs provide whiter, brighter light rated at 1,000 lumens, providing clearer, improved visibility
- Solid-state LED design is impervious to damage from shock and vibration
- Retrofit or replacement is quick and easy, with a standard 16x4 cut-out necessary for installation
- LEDs are fully encapsulated in epoxy to prevent damage caused by moisture and corrosives
- Hardwired design

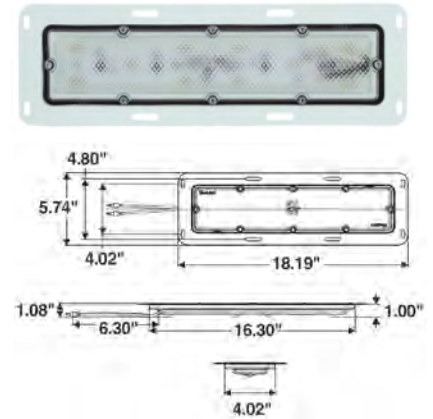

Part Number	Lamp Connector	Plug Side 1	Plug Side 2	Lens Color	Lens Material	Mount Color	Volts	Amps	Motion Sensor
80253C	Hardwired	Hardwired	.180 Bullet	Clear	PC	White	12	2	No
80255C	Hardwired	Hardwired	.180 Bullet	Clear	PC	White	12	2	Yes

## 84 SERIES, LED, 12 DIODE, 2" x 48", 4 SCREW BRACKET MOUNT



- LED light source provides more even truck cargo light
- Aluminum housing won't rust
- Less susceptible to shock and vibration
- Reduces shadowed areas and increases visibility
- Can be mounted almost anywhere
- LEDs draw less current, creating less heat
- Designed for interior use only



Part Number	Lamp Connector	Plug Side 1	Plug Side 2	Lens Color	Lens Material	Mount Color	Volts	Amps	Notes
84200C	Hardwired	Hardwired	.180 Bullet	Clear	PC	White	12	1.27	4 in corner

## SIGNAL-STAT, LED, 4 DIODE, 3" x 10", 2 SCREW BRACKET MOUNT



- Ideal for flood, cargo, step, locker and overhead lighting
- Can be fitted in semi-trailer, trailer, box van, mini-bus/coach, emergency services, utilities, recovery and load-handling vehicles
- Utilizes an extremely reliable slimline design and combines both dual-voltage and dual-polarity functions
- Instant switch on with easy surface mount and offset optical design making it easy to position in any orientation to direct light to the desired area
- Low-profile, waterproof to IP67 and reliable to a temperature of minus 40° C
- ECE-approved LED interior lamp to ECE 95/54, EEC 2000/2, ECE Reg. 10

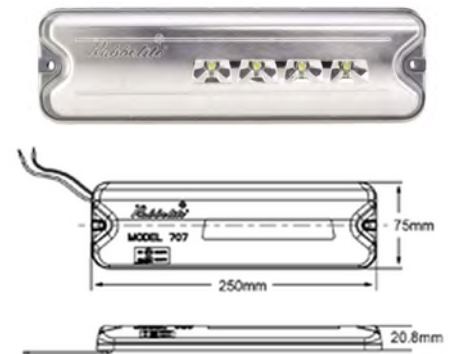

Part Number	Lamp Connector	Plug Side 1	Plug Side 2	Lens Color	Lens Material	Mount Color	Volts	Amps
8013	Hardwired	Hardwired	Blunt Cut	Clear	PC	Gray	12 24	1.15

## 10<sup>®</sup> SERIES, INCANDESCENT, 1 BULB, 2.5", GROMMET MOUNT



- Lens and housing are sonically sealed
- High-impact polycarbonate construction
- 15,000 hour rated bulb life
- Replaces Signal-Stat 1010W



Part Number	Lamp Connector	Lens Color	Lens Material	Volts	Amps
10202C	PL-10	Clear	PC	12	0.33
10204C	PL-10	Clear	PC	24	0.17

## SUPER 10<sup>®</sup> SERIES, INCANDESCENT, 1 BULB, 2.5", GROMMET MOUNT



- Lens and housing are sonically sealed
- High-impact polycarbonate construction
- 15,000 hour rated bulb life
- Replaces Signal-Stat 1010W



Part Number	Lamp Connector	Lens Color	Lens Material	Volts	Amps
10209C	PL-10	Clear	PC	12	0.33

## 12<sup>®</sup> SERIES, INCANDESCENT, 1 BULB, 2" x 3", BRACKET MOUNT



- Standard replacement for UPS
- Sonically sealed lens and housing
- 15,000 rated 12V bulb life
- 12V and 24V models
- Suitable for PC requirements when mounted horizontally on a 45-degree angle
- Optional mounting gasket to improve seal between lamp and body

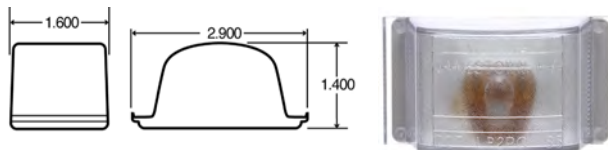

Part Number	Lamp Connector	Lens Color	Lens Material	Volts	Amps
12200C	PL-10	Clear	PC	12	0.33

INCANDESCENT

12 SERIES

## 15<sup>®</sup> SERIES, INCANDESCENT, 1 BULB, 1" x 2", BRACKET MOUNT



- High-impact polycarbonate sonically sealed lens and housing
- Features 15,000 hour long-life bulb
- Replaces Signal-Stat 1500W

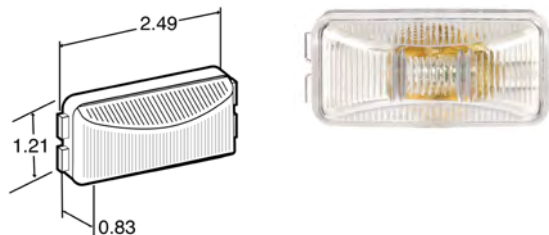

Part Number	Lamp Connector	Lens Color	Lens Material	Volts	Amps
15200C	PL-10	Clear	PC	12	0.33

INCANDESCENT

15 SERIES

## 19<sup>®</sup> SERIES, INCANDESCENT, 2 BULB, 1" x 4", BRACKET MOUNT



- High-impact polycarbonate sonically sealed lens and housing
- Features 15,000 hour long-life bulb

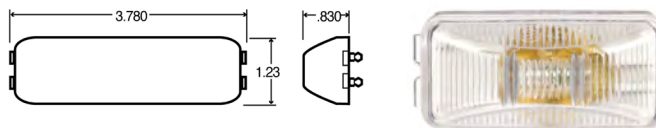

Part Number	Lamp Connector	Lens Color	Lens Material	Volts	Amps
19200C	19 Series Male Pin	Clear	PC	12	0.33

INCANDESCENT

19 SERIES

INCANDESCENT

20 SERIES

## 20 SERIES, INCANDESCENT, 1 BULB, 2", 2 SCREW BRACKET MOUNT

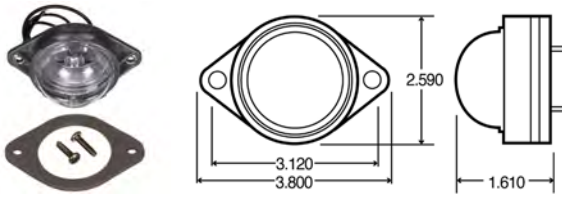

- Features beehive profile lens which produces maximum 90-degree edge lighting
- Snap-in lens for quick and easy replacement
- Utility lamp, #20308 not intended for dome lamp use



Part Number	Lamp Connector	Plug Side 1	Plug Side 2	Lens Color	Lens Material	Mount Color	Volts	Amps
20302	Hardwired	Hardwired	Stripped End	Clear	PC	Silver	12	0.97
20308	Hardwired	Hardwired	.180 Bullet	Clear	PC	Silver	12	2.1

INCANDESCENT

26 SERIES

## 26 SERIES, INCANDESCENT, 1 BULB, BRACKET MOUNT, KIT

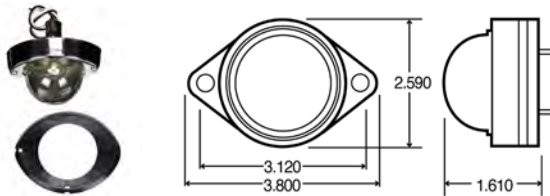

- Stainless steel housing will not rust or corrode
- Glass lens holds up to extreme temperatures
- Mounts with two # 10 screws on 1.625" centers
- Mounting hole requires 13/16" diameter cutout



Part Number	Lamp Connector	Plug Side 1	Plug Side 2	Lens Color	Lens Material	Mount Color	Volts	Amps	
26391C	Hardwired	Hardwired	Stripped End	Clear	Glass	Silver	24	1.2	
26392C	Hardwired	Hardwired	Stripped End	Clear	Glass	Silver	24	1.2	w/ground wire
26393C	Hardwired	Hardwired	Stripped End	Clear	Glass	Silver	12	1.43	
26394C	Hardwired	Hardwired	Stripped End	Clear	Glass	Silver	12	1.43	w/ground wire

INCANDESCENT

30 SERIES

## 30<sup>®</sup> SERIES, INCANDESCENT, 1 BULB, 2", 2 SCREW BRACKET MOUNT



- High-impact polycarbonate construction
- Lens and housing are sonically sealed
- 15,000 hour rated 12V bulb life
- Replaces Signal-Stat 1030W



Part Number	Lamp Connector	Plug Side 1	Plug Side 2	Lens Color	Lens Material	Mount Color	Volts	Amps
30200C	PL-10	No Plug	No Plug	Clear	PC		12	0.33
30206C	PL-10	No Plug	No Plug	Clear	PC		24	0.17

## 40<sup>®</sup> SERIES, INCANDESCENT, 1 BULB, 4", GROMMET MOUNT



- Popular option on new Wabash trailers
- Uniquely designed shock mount extends lamp life
- For auxiliary use only
- Specially designed lens allows lamp to angle light away from trailer rather than straight back
- Output light up to 10' on sides at a 45 degree angle
- Illuminates area seen by driver through side mirrors

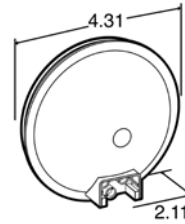

Part Number	Lamp Connector	Plug Side 1	Plug Side 2	Lens Color	Lens Material	Volts	Amps	
40203	PL-2	No Plug	No Plug	Clear	PC	12	1.44	Angled Illumination
40207	PL-2	No Plug	No Plug	Clear	PC	12	2.1	Angled Illumination
40211	PL-2	No Plug	No Plug	Clear	PC	12	1.44	Clear Back
40227	PL-2	No Plug	No Plug	Clear	PC	12	1.44	w/Epoxy Fill

## 40<sup>®</sup> SERIES, INCANDESCENT, 1 BULB, 4", GROMMET MOUNT, KIT



- Features clear back housing
- Sealed polycarbonate lens and housing
- Grommet kit features flush mounting in a 4 1/2" hole

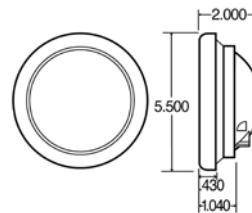

Part Number	Lamp Connector	Plug Side 1	Plug Side 2	Lens Color	Lens Material	Mount Color	Volts	Amps	Kit Includes
40003	PL-2	PL-2	Stripped End/Ring Terminal	Clear	PC	Black	12	1.44	40203 light, 40700 grommet, 94922 plug
40011	PL-2	PL-2	Stripped End/Ring Terminal	Clear	PC	Black	12	1.44	40211 light, 40703 grommet, 94961 plug

INCANDESCENT

40 SERIES

### 40® SERIES, INCANDESCENT, 1 BULB, 4", FLANGE MOUNT

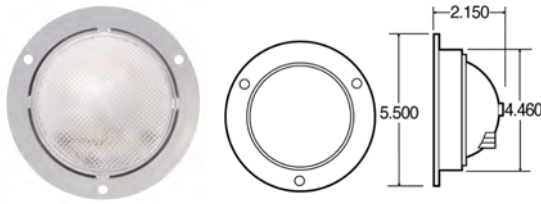

- Polycarbonate lens and housing are sonically sealed
- Bulb is shock-mounted for extended life
- Upgrade to LED lighting systems using Truck-Lite's Super 44 Series



Part Number	Lamp Connector	Plug Side 1	Plug Side 2	Lens Color	Lens Material	Mount Color	Volts	Amps
40223	PL-2	No Plug	No Plug	Clear	PC	Gray	12	1.44

INCANDESCENT

40 SERIES

### 40® SERIES, INCANDESCENT, 1 BULB, 4", FLANGE MOUNT, KIT

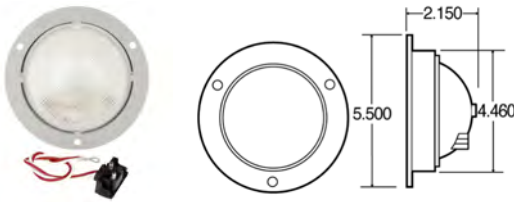

- Polycarbonate lens and housing are sonically sealed
- Bulb is shock-mounted for extended life
- Upgrade to LED lighting systems using Truck-Lite's Super 44 Series



Part Number	Lamp Connector	Plug Side 1	Plug Side 2	Lens Color	Lens Material	Mount Color	Volts	Amps	Kit Includes
40023	PL-2	PL-2	Stripped End/ Ring Terminal	Clear	PC	Gray	12	1.44	40223 light, 94992 grommet

INCANDESCENT

1 BULB

### INCANDESCENT, 1 BULB, 1", ROUND, 2 SCREW, BRACKET MOUNT

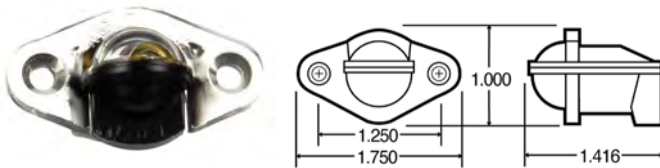

- Variety of interior and exterior applications
- Compact sealed polycarbonate construction



Part Number	Lamp Connector	Plug Side 1	Plug Side 2	Lens Color	Lens Material	Mount Color	Volts	Amps
04116	PL-10	No Plug	No Plug	Clear	PC	Clear	12	0.33

## INCANDESCENT, 1 BULB, 1", ROUND, 2 SCREW BRACKET MOUNT, KIT



- Variety of interior and exterior applications
- Sealed polycarbonate construction

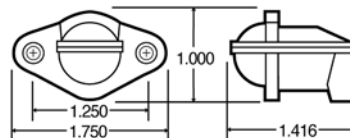

Part Number	Lamp Connector	Plug Side 1	Plug Side 2	Lens Color	Lens Material	Mount Color	Volts	Amps	Kit Includes
04115	PL-10	No Plug	No Plug	Clear	PC	Clear	12	0.33	
26001	PL-10	PL-10	Stripped End/Ring Terminal	Clear	PC	Clear	12	0.33	94854 plug

## INCANDESCENT, 1 BULB, 2" x 5", RECTANGULAR, 2 SCREW BRACKET MOUNT



- Designed for easy recessed mount replacement
- Features plated steel housing and acrylic lens
- Lens held by two screws for easy bulb replacement
- Requires 4-3/16" X 1-5/8" cut-out

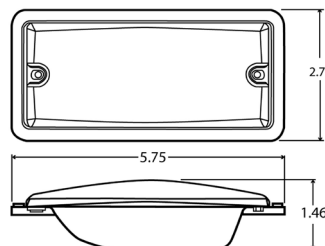

Part Number	Lamp Connector	Plug Side 1	Plug Side 2	Lens Color	Lens Material	Mount Color	Volts	Amps
80490	Hardwired	Hardwired	Stripped End	Clear	Acrylic	Silver	12	0.94

## INCANDESCENT, 1 BULB, 3" x 7", RECTANGULAR, 2 SCREW BRACKET MOUNT



- Flush mounts on two screws at 6.0" centers
- Requires a 2" x 5-1/4" hole
- Grounds through mounting screws
- Functions as an interior dome, a compartment or utility lamp
- Heavy-duty steel and acrylic construction

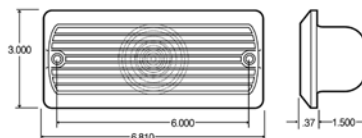

Part Number	Lamp Connector	Plug Side 1	Plug Side 2	Lens Color	Lens Material	Volts	Amps
81350	Hardwired	Hardwired	Stripped End	Clear	Acrylic	12	1.04

INCANDESCENT

1 BULB

INCANDESCENT

1 BULB

INCANDESCENT

1 BULB

## SIGNAL-STAT, INCANDESCENT, 1 BULB, 2" x 5", 2 SCREW BRACKET MOUNT

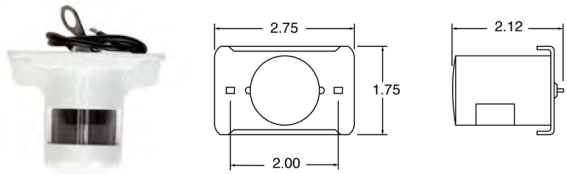

- Twist-off lens hood for easy bulb replacement
- Lights up instrument panel and compartments
- Surface mounts on 2" centers
- Grounds through mounting screws
- Polycarbonate housing will not rust



Part Number	Lamp Connector	Plug Side 1	Plug Side 2	Lens Color	Lens Material	Mount Color	Volts	Amps
433WD	Hardwired	Hardwired	Stripped End/ Ring Terminal	Clear	Acrylic	White	12	0.35

## SIGNAL-STAT, INCANDESCENT, 1 BULB, 1" x 2", 2 SCREW BRACKET MOUNT

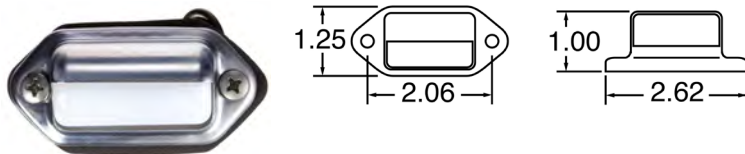

- Focused light output
- Hooded guard to stop glare
- Separate ground wire



Part Number	Lamp Connector	Plug Side 1	Plug Side 2	Lens Color	Lens Material	Mount Color	Volts	Amps
434WD	Hardwired	Hardwired	Stripped End	Clear	Acrylic	Chrome	12	0.27

## SIGNAL-STAT, INCANDESCENT, 1 BULB, 2" x 6", 2 SCREW BRACKET MOUNT



- Navistar replacement
- Use for dome or utility lamp
- Surface mount for easy installation



Part Number	Lamp Connector	Plug Side 1	Plug Side 2	Lens Color	Lens Material	Mount Color	Volts	Amps
4094SW	PL-2	Female PL-2	Packard Connector	Clear	PC	White	12	1

INCANDESCENT

SIGNAL-STAT

INCANDESCENT

SIGNAL-STAT

INCANDESCENT

SIGNAL-STAT

## SIGNAL-STAT, INCANDESCENT, 1 BULB, 2" x 4", 4 SCREW BRACKET MOUNT



- Use for dome or utility lamp
- Raised lens for maximum output
- Surface mount for easy installation

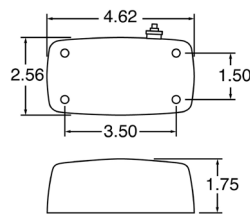

Part Number	Lamp Connector	Plug Side 1	Plug Side 2	Lens Color	Lens Material	Mount Color	Volts	Amps
549SWD	Hardwired	Hardwired	Stripped End	Clear	PC	Silver	12	2.1

INCANDESCENT

SIGNAL-STAT

## SIGNAL-STAT, INCANDESCENT, 2 BULB, 1" x 2", 2 SCREW BRACKET MOUNT



- Snap-in lens for easy bulb replacement
- Vulcanized rubber housing with aluminum base

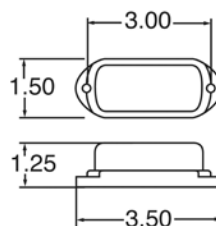

Part Number	Lamp Connector	Plug Side 1	Plug Side 2	Lens Color	Lens Material	Mount Color	Volts	Amps
1506W	Hardwired	Hardwired	Stripped End	Clear	Acrylic	Black	12	0.27

INCANDESCENT

SIGNAL-STAT

## SIGNAL-STAT, INCANDESCENT, 2 BULB, 2" x 4", 2 SCREW BRACKET MOUNT



- 15,000-hour bulbs
- Corrosion-proof Permastat housing
- Snap-on lens for easy bulb replacement

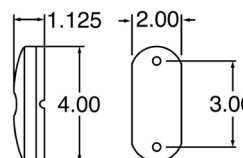

Part Number	Lamp Connector	Plug Side 1	Plug Side 2	Lens Color	Lens Material	Volts	Amps
1211W	Hardwired	Hardwired	Blunt Cut	Clear	Acrylic	12	0.27

INCANDESCENT

SIGNAL-STAT

FLUORESCENT

2 SCREW

## FLUORESCENT, 2 BULB, 5" x 18", 2 SCREW BRACKET MOUNT

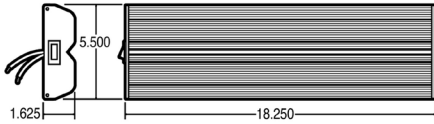

- High-impact snap-on polycarbonate lens
- Metal housing is white epoxy powder-coated
- Installation is easy with integrated 2-pin Packard connector
- Lamp plug connector mates with Packard connector #12129081
- Upgrade to LED lighting systems using Truck-Lite's 80 Series



Part Number	Lamp Connector	Plug Side 1	Plug Side 2	Lens Color	Lens Material	Mount Color	Volts	Amps
80444	Hardwired	Hardwired	Stripped End	Clear	Acrylic	Silver	12	2.2

FLUORESCENT

4 SCREW

## FLUORESCENT, 2 BULB, 6" x 21", 4 SCREW BRACKET MOUNT

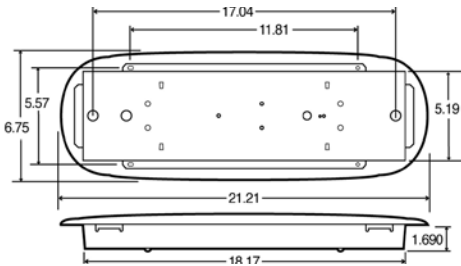

- Designed for heavy-use service vehicles such as industrial supply trucks, emergency vehicles or mobile kitchens
- Clear acrylic snap-lock lens
- Anodized aluminum housing features black end caps
- Two 15W fluorescent tubes produce light output of 1650 lumens
- Convenient on/off switch
- Upgrade to LED lighting systems using Truck-Lite 80 Series Products



Part Number	Lamp Connector	Plug Side 1	Plug Side 2	Lens Color	Lens Material	Mount Color	Volts	Amps
80418	Hardwired	Hardwired	Packard Connector 12129155	Clear	PC	White	12	2.2